

Flame detector FDU 510, FDU 520

OPERATING INSTRUCTIONS

· Edition 02.24 · EN · 03251625



CONTENTS

1 Safety	1
2 Checking the usage	2
3 Installation	3
4 Cable selection	3
5 Wiring	3
6 Adjustment	5
7 Commissioning	5
8 Assistance in the event of malfunction	6
9 Reading or setting flame signal, parameters, statistics	8
10 Parameters and values	9
11 Legend	9
12 Technical data	9
13 Safety instructions	10
14 Logistics	10
15 Accessories	11
16 Certification	11
17 Disposal	12

1 SAFETY

1.1 Please read and keep in a safe place



Please read through these instructions carefully before installing or operating. Following the installation, pass the instructions on to the operator. This unit must be installed and commissioned in accordance with the regulations and standards in force. These instructions can also be found at www.docuthek.com.

1.2 Explanation of symbols

1, 2, 3, a, b, c = Action

→ = Instruction

1.3 Liability

We will not be held liable for damage resulting from non-observance of the instructions and non-compliant use.

1.4 Safety instructions

Information that is relevant for safety is indicated in the instructions as follows:

⚠ DANGER

Indicates potentially fatal situations.

⚠ WARNING

Indicates possible danger to life and limb.

⚠ CAUTION

Indicates possible material damage.

All interventions may only be carried out by qualified gas technicians. Electrical interventions may only be carried out by qualified electricians.

1.5 Conversion, spare parts

All technical changes are prohibited. Only use OEM spare parts.

2 CHECKING THE USAGE

Flame detectors FDU 510 and FDU 520 are used to monitor gas burners in intermittent (FDU 510) or continuous (FDU 520) operation. They can be used as replacements for flame detectors IFW, R4343 or BC1000. The flame detectors can be used with suitable burner control units (e.g. BCU 560) or with a fail-safe PLC with a standard-compliant flame supervision device. The FDUs can be used for multi-flame control or for multi-point monitoring (for example on a line-style or duct burner).

FDU 510

For monitoring gas burners in intermittent operation

FDU 520

For monitoring gas burners in continuous operation

This function is only guaranteed when used within the specified limits – see page 9 (12 Technical data). Any other use is considered as non-compliant.

2.1 Type code

FDU	Flame detector
510	Series 510 for intermittent operation
520	Series 520 for continuous operation
Q	Mains voltage: 120 V AC, 50/60 Hz
W	Mains voltage: 230 V AC, 50/60 Hz
0	Flame control with flame rod
1	Flame control with UVS
2	Flame control with UVC
9	Flame control with series C7027, C7035, C7044
T2	Switch-off threshold: 2 μ A
T5	Switch-off threshold: 5 μ A
T7	Switch-off threshold: 7 μ A
1	Safety time during operation: 1 s
4	Safety time during operation: 4 s
O1	Contacts: 1 NO contact, 1 NC contact
O2	Contacts: 2 NO contacts
-0	No output
-1	Flame signal intensity: 0–5 V output
K0	No connection plugs
K1	Connection plugs with screw terminals
K2	Connection plugs with spring force terminals

2.2 Part designations

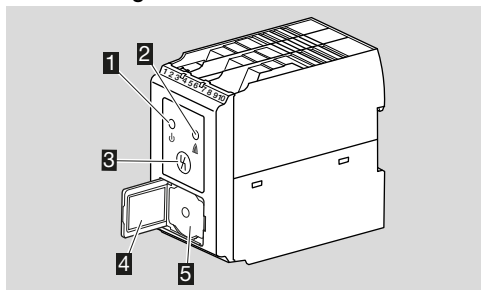

- 1 Red/green LED for operating state
- 2 Yellow LED for flame signal
- 3 Reset button

4 Type label

5 Connection for opto-adaptor

2.3 Type label

Input voltage: see type label.

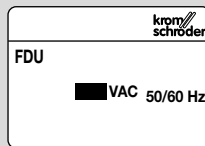

3 INSTALLATION

⚠ CAUTION

- Dropping the device can cause permanent damage. In this event, replace the entire device and associated modules before use.
- Installation position: vertically upright, horizontal or tilted to the left or right.
- The device is designed for mounting on horizontally aligned 35 × 7.5 mm DIN rails.

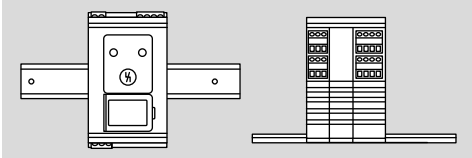

- If the DIN rail is aligned vertically, end clamps are required (e.g. Clipfix 35 by Phoenix Contact) to prevent the device from slipping.

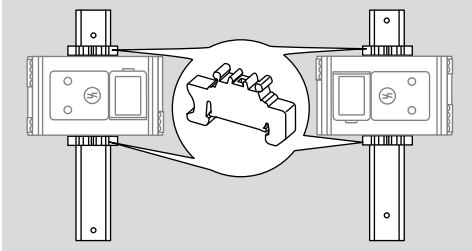

- Install in a clean environment (e.g. a control cabinet) with an enclosure ≥ IP 54, whereby no condensation is permitted.

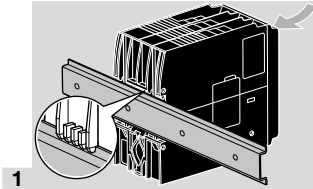

4 CABLE SELECTION

- Use cables suitable for the type of operation and complying with local regulations.
- Signal and control line for screw terminals max. 2.5 mm² (min. AWG 24, max. AWG 12), for spring force terminals max. 1.5 mm² (min. AWG 24, max. AWG 12).
- Do not route the device's cables in the same cable duct as frequency converter cables or cables emitting strong fields.
- External electrical interference must be avoided.

Ionization, UV, C70xx cable

- The flame signal is adversely affected by EMC influences.
- Cable lengths of 50 m are acceptable if there is no EMC interference.
- As the length of the ionization/UV/C70xx cable increases, the flame signal intensity may drop off.
- Lay cables individually (with low capacitance) and, if possible, not in a metal conduit.

5 WIRING

- 1 Disconnect the system from the electrical power supply.
 - Screw terminals or spring force terminals are available for the FDU:
Screw terminal, Order No.: 74924898.
Spring force terminal, Order No.: 74924899.
- 2 Wire as shown on the connection diagram – see page 4 (5.1 Connection diagram).
 - Ensure a good PE (ground) wire connection between burner ground (terminal 8) on the FDU and the burners.
 - Ensure that a clean sinusoidal voltage is applied to the FDU so as to avoid mains voltage errors due to irregularities in the mains voltage.

5.1 Connection diagram

→ See page 9 (11 Legend).

Standard

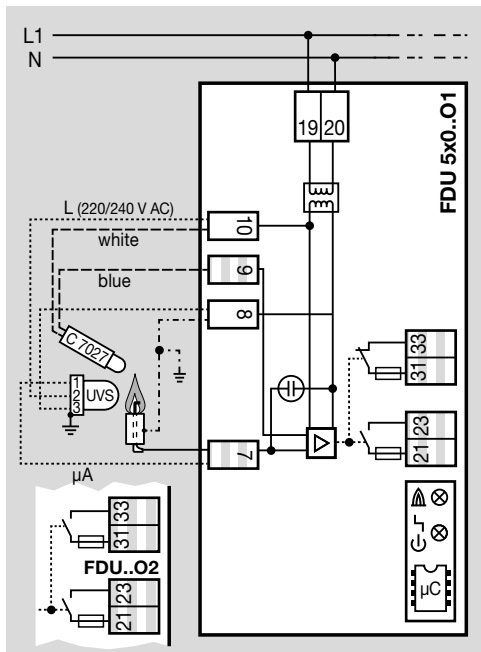

With 0 to 5 V output

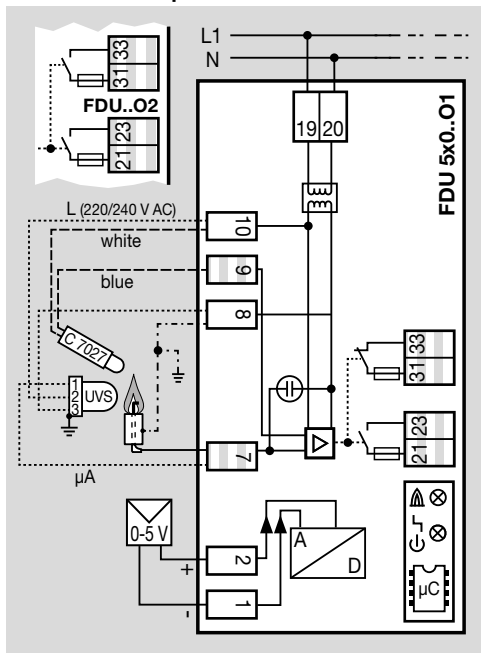

UVC connected to FDU 520

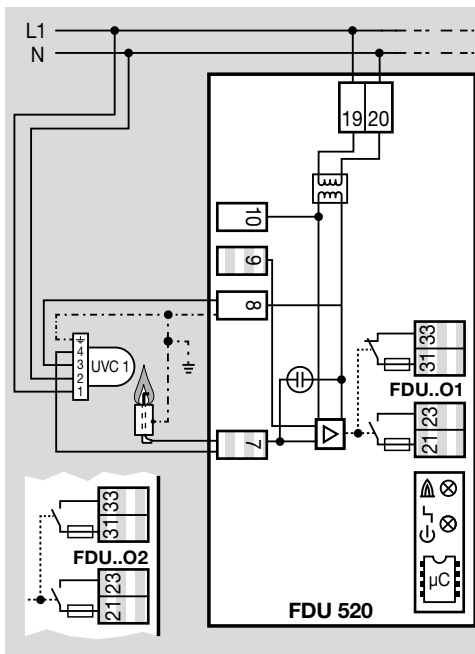

UVC connected to FDU 520 with 0 to 5 V output

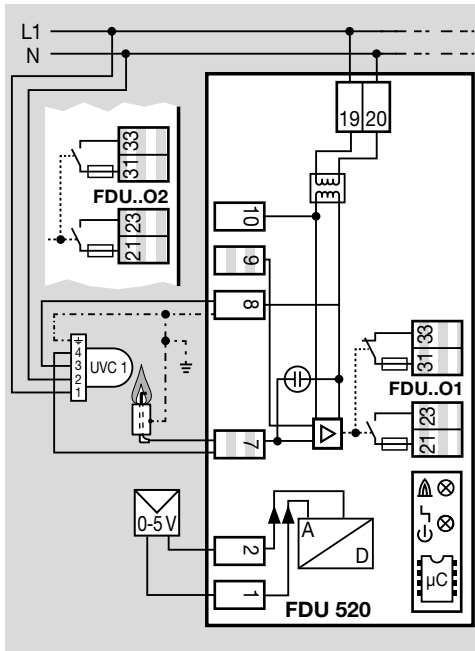

6 ADJUSTMENT

In certain cases, it may be necessary to change the parameters set at the factory. Using the separate software package BCSoft and the opto-adapter PCO 200, it is possible to modify parameters on the FDU, such as the switch-off threshold or the type of flame control, see also the “Accessories” section of the operating instructions or the Technical Information bulletin and the [BCSoft operating instructions at www.docuthek.com](http://www.docuthek.com).

- 1 Change the parameter settings using BCSoft.
 - Access to the device via the network using BCSoft is not possible to ensure network security.
 - The factory settings are secured with a programmable password (1234).
 - If the password is changed, it must be entered in the system documentation.
- 2 Click on “Confirm Changes” to transfer the parameter changes from BCSoft to the FDU.
 - A pop-up window will appear stating that the data transfer has been completed.
- 3 Click on “OK” in the pop-up window.
 - A window will open in BCSoft to confirm the parameter change.
 - The green LED on the FDU will flash until the parameter change has been confirmed.

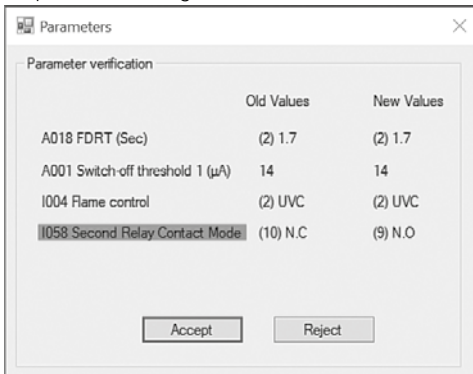

- 4 Click on “Accept” in the window to confirm the parameter change or on “Reject” to discard the changes.
 - The parameter changes must be accepted for the FDU to apply the new parameter settings. Otherwise, the FDU will retain the old parameter settings.

Switch-off threshold

- The switch-off threshold can be set to a value between 2 and 20 µA.
- If the FDU is used on a burner control unit, the switch-off threshold cannot be set on the burner control unit.

Parameter	Parameter value	Factory default settings
A001	2–20 = Burner 1 flame signal switch-off threshold in µA (depending on parameter I004)	> 2 µA where I004 = 0, > 5 µA where I004 = 1, 5 µA where I004 = 2, > 2 µA where I004 = 9

7 COMMISSIONING

⚠ WARNING

Risk of explosion! Check the system for tightness before commissioning.

Before commissioning, make sure that parameter I004 (= Choice of flame sensor) is set on the FDU so that it is in line with the range approved for the application to ensure that no damage occurs.

- 1 Switch on the system.
 - The LEDs (yellow, red and green) will flash during initialization of the FDU.
 - The FDU is ready for use as soon as the green LED is lit.
 - A flame is detected (delay of ≤ 1 s) as soon as the yellow LED is lit.
 - The red LED will be lit in the event of a fault.

8 ASSISTANCE IN THE EVENT OF MALFUNCTION

⚠ WARNING

Electric shocks can be fatal!

- Before working on possible live components, ensure the unit is disconnected from the power supply.
- Fault-clearance must only be undertaken by authorized trained personnel
- Do not carry out repairs on the unit on your own as this will cancel our guarantee. Unauthorized repairs or incorrect electrical connections can cause the device to become defective.
- Resets may only be conducted by authorized trained personnel with continuous monitoring of the burner to be reset.

Fault lock-out/Device error

→ The red LED is lit.

Reset the FDU by pressing and holding the reset button > 5 s.

→ If the red LED is still lit, do a power cycling and then reset the FDU by pressing and holding the reset button > 5 s.

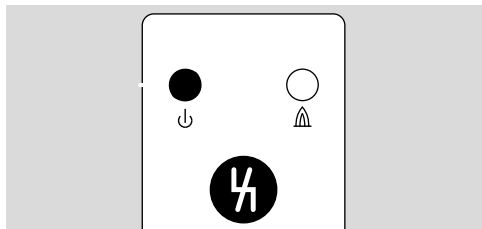

? Fault

! Cause

• Remedy

→ If the FDU does not react even though all faults have been remedied, remove the unit and send it to the manufacturer for inspection.

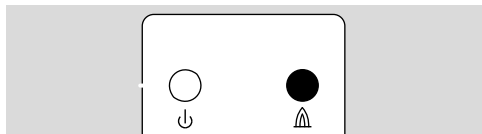

? The yellow LED “Flame signal” is lit although there is no flame.

- ! The flame detector is influenced by the flames of other burners, e.g. by reflection on the furnace walls.
 - Position the UV sensor so that it can only “see” its own dedicated flame (e.g. use viewing tube).
- ! Sensitivity of the flame detector is too high.
 - Increase the switch-off threshold using BCSof.
- ! The UV tube is defective.

- Replace the UV tube; refer to the operating instructions of the UV sensor for more information.

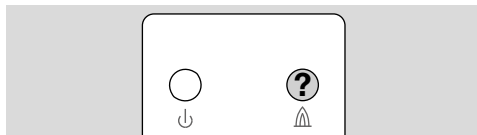

? For UV control: the yellow LED “Flame signal” is not lit although there is a flame.

- ! The UV sensor is dirty, e.g. sooted.
 - Clean the quartz glass disc/lens.
- ! There is moisture in the burner adapter.
 - Vent the burner adapter.
- ! The UV sensor is too far away from the flame.
 - Reduce the distance.
- ! No UV tube has been inserted.
 - Insert a UV tube.
- ! After many hours of operation, the flame signal becomes weaker, the UV tube ages.
 - Replace the UV tube; refer to the operating instructions of the UV sensor for more information.

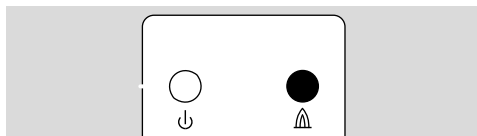

? The yellow LED “Flame signal” is lit, but the burner control unit does not detect a flame signal.

- ! Short-circuit or discontinuity in the wiring between the flame detector and the burner control unit/control unit.
- ! UV flame detector or burner control unit is not correctly wired.
- ! The flame signal cable is too long.
- ! Sources of interference, e.g. ignition transformers, are influencing the flame signal.
 - Remedy fault.

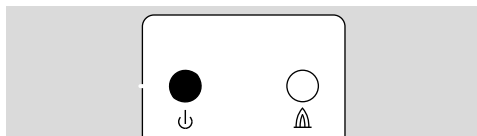

? The red LED “Fault” is lit.

- ! The unit is defective.
 - Remove the unit and return it to the manufacturer for inspection.
- ! An internal error occurred.
 - Reset the unit by pressing the reset button.

- ! The FDU temperature is below -25°C or above $+65^{\circ}\text{C}$.
 - Make sure that the FDU temperature is within the range of -20°C to $+60^{\circ}\text{C}$.
- Error-free operation is only guaranteed within the range of -20°C to $+60^{\circ}\text{C}$.

- ! The FDU mains voltage exceeds the limits for undervoltage or overvoltage.
 - Make sure that the mains voltage is correct.

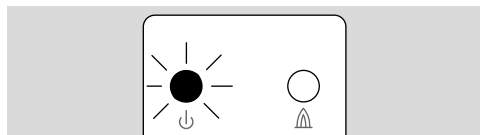

? **The red LED “Fault” flashes (indication of temperature alarm status or bus module connection fault).**

- ! The PCB temperature exceeds the warning limits. The PCB temperature is between -20°C and -25°C or between 60°C and 65°C .
- The function of the FDU is not restricted.
- As soon as the FDU temperature is in the range between -20°C and $+60^{\circ}\text{C}$, the red LED stops flashing.

- ! The FDU is connected to the bus module, but no connection with the host (PLC or BCSofT) is established.
 - Check the IP address.
 - Check the communication with the host.

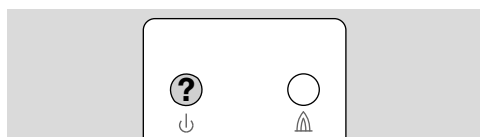

? **The green LED “Ready for operation” is not lit.**

- ! Incorrect wiring.
 - Check the wiring, see page 4 (5.1 Connection diagram).
- ! Unit defective.
 - Send back the unit.
- ! FDU has suffered a device error.
 - Read the error with BCSofT and react accordingly.
- ! FDU has carried out a fault lock-out.
 - Read the error with BCSofT and react accordingly.

? **The burner ignites in pulses.**

- ! The FDU reacts to an ignition spark.
 - Reposition the UV sensor so that it cannot “see” the ignition spark.

- Use a burner control unit that is able to distinguish between an ignition spark and a flame signal.

? **The burner control unit performs a fault lock-out during start-up with the fault message “No flame” or during operation indicating “Flame failure”.**

- ! The highly fluctuating flame signal temporarily falls below the switch-off threshold.
 - Reduce the distance between UV sensor and flame.
 - Position the UV sensor so that it can “see” the flame without hindrance (e.g. smoke curtain).
- ! The switch-off threshold is set too high.
 - Reduce the switch-off threshold using BCSofT.

Reading fault messages using BCSofT

- Fault messages can be read from the FDU using the opto-adaptor PCO 200, which is an additional extra, and the BCSofT program, see also page 11 (15 Accessories) and the BCSofT operating instructions at www.docuthek.com.

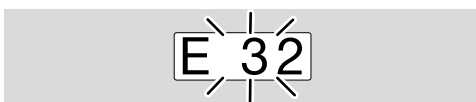

? **The BCSofT error history on the Statistics tab displays E 32.**

- ! Supply voltage too low or too high.
 - Operate the FDU in the specified mains voltage range (mains voltage $+10/-15\%$, 50/60 Hz).
- ! An internal device error occurred.
 - Remove the unit and return it to the manufacturer for inspection.

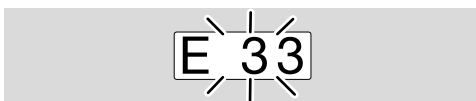

? **The BCSofT error history on the Statistics tab displays E 33.**

- ! Faulty parameterization.
 - Check parameter settings using BCSofT.
- ! An internal device error occurred.
 - Remove the unit and return it to the manufacturer for inspection.

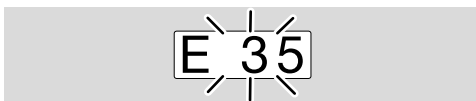

? **The BCSofT error history on the Statistics tab displays E 35.**

- ! Incompatible or defective bus module.

- Replace bus module with a functional device.

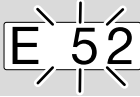

? The BCSoft error history on the Statistics tab displays E 52.

- ! The FDU is permanently reset by remote reset.
 - Check activation of the remote reset input via the bus.
 - Apply voltage to the remote reset input for around 1 s to reset the device.



? The BCSoft error history on the Statistics tab displays n 0.

- ! No connection established between FDU and PLC.
 - Check the wiring.
 - Check the PLC program to ensure that the network name and IP configuration of the FDU are valid.
 - Switch on the PLC.

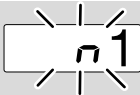

? The BCSoft error history on the Statistics tab displays n 1.

- Fault occurs on devices with fieldbus communication with address check (A080 = 1) only.
- ! An invalid or incorrect address has been set on the bus module.
 - Assign the correct address (001 to FEF) to the bus module.

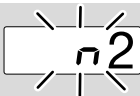

? The BCSoft error history on the Statistics tab displays n 2.

- ! The bus module has received an incorrect configuration from the PLC.
 - Check whether the correct GSD file was imported.

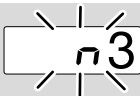

? The BCSoft error history on the Statistics tab displays n 3.

- Fault occurs on devices with fieldbus communication with address check (A080 = 1) only.
- ! The FDU has been assigned an invalid network name or has not been assigned a network name in the PLC.
 - Assign a network name corresponding to the default network name (fdu-510-xxx) or use the default name as a suffix of an individually assigned name in the following form: "individual-partofnamefdu-510-xxx".
- "xxx" stands for the address set on the bus module (e.g. 4A5).

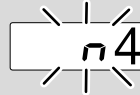

? The BCSoft error history on the Statistics tab displays n 4.

- ! PLC in STOP position.
 - Check whether the PLC can be started.

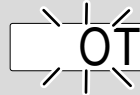

? The BCSoft error history on the Statistics tab displays OT.

- ! The ambient temperature is too high for the FDU (excessive temperature).
- The display disappears as soon as the temperature has dropped to the specified setpoint.

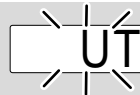

? The BCSoft error history on the Statistics tab displays UT.

- ! The ambient temperature is too low for the FDU (insufficient temperature).
- The display disappears as soon as the temperature has risen to the specified setpoint again.

9 READING OR SETTING FLAME SIGNAL, PARAMETERS, STATISTICS

Using an optionally available opto-adaptor, it is possible to set parameters and read analysis and diagnostic information from the FDU using the BCSoft program, see "Accessories" section of the operating instructions or the Technical Information bulletin and the BCSoft operating instructions at www.docuthek.com.

10 PARAMETERS AND VALUES

→ Can be set using BCSoft





Application parameters

Parameter No.	Parameter name Parameter value
<i>RC01</i>	Switch-off threshold 1 2–20 = μ A
<i>RC18</i>	Flame failure detection time 1 = 0.7 s 2 = 1.7 s 3 = 2.7 s 4 = 3.7 s
<i>RC80</i>	Fieldbus communication 0 = Off 1 = With address check 2 = No address check

Interface parameters

Parameter No.	Parameter name Parameter value
<i>IO04</i>	Flame control 0 = Ionization 1 = UVS 2 = UVC 9 = C7027, C7035, C7044
<i>IO58</i>	Function of contact 31/33 9 = Flame signal (NO contact) 10 = Flame signal (NC contact)

11 LEGEND

	Ready for operation
	Burner
	Burner flame signal
	Fault signal
	Input/Output, safety circuit

12 TECHNICAL DATA

WARNING

Information pursuant to REACH Regulation No. 1907/2006, Article 33.

The device contains substances of very high concern which are listed in the Candidate List of the European REACH Regulation No. 1907/2006.

Ambient conditions

Condensation and dew in and on the unit are not permitted.

Avoid direct sunlight or radiation from red-hot surfaces on the unit.

Avoid corrosive influences, e.g. salty ambient air or SO₂.

Permitted relative humidity: min. 5%, max. 95%.

The unit may only be stored/installed in enclosed rooms/buildings that are not accessible to the public.

Ambient temperature: -20 to +60°C (-4 to +140°F), no condensation/icing permitted.

Transport temperature = ambient temperature.

Storage temperature: -20 to +80°C (-4 to +176°F).

Enclosure: IP 20 pursuant to IEC 529.

Installation location: min. IP 54 (for installation in a control cabinet).

Permitted operating altitude: < 2000 m AMSL.

Mechanical data

Dimensions (W x H x D): 60 x 115 x 112 mm.

Weight: 0.4 kg.

Connections:

Screw terminals:

nominal cross-section 2.5 mm²,

wire cross-section (rigid) min. 0.2 mm²,

wire cross-section (rigid) max. 2.5 mm²,

wire cross-section AWG min. 24,

wire cross-section AWG max. 12.

Spring force terminals:

nominal cross-section 2 x 1.5 mm²,

wire cross-section min. 0.2 mm²,

wire cross-section AWG min. 24,

wire cross-section AWG max. 16,

wire cross-section max. 1.5 mm²,

rated current 10 A (8 A UL), to be observed in case of daisy chain.

Electrical data

Supply voltage:

FDU..Q: 120 V AC, -15/+10%, 50/60 Hz, \pm 5%,

FDU..W: 230 V AC, -15/+10%, 50/60 Hz, \pm 5%,

for grounded or ungrounded mains.

Power consumption: < 10 VA.

Flame control:

with UV sensor or flame rod.

For intermittent or continuous operation.

Flame signal current:

ionization control: 1–25 μ A,

UVS/UVC control: 1–25 μ A,

C70xx control: 1–15 μ A.

ionization/UVC/UVS/C70xx/C72xx cable:

max. 50 m (164 ft).

Contact rating:

max. 2 A, $\cos \varphi \geq 0.6$,

min. 2 mA, $\cos \varphi \geq 0.6$.

Power rating for SIL 3 applications:

max. 0.1 A, $\cos \varphi = 1$ for both NO and NC outputs, 230 V AC or 24 V DC.

Number of operating cycles:

max. 250,000.

12.1 Designed lifetime

This information on the designed lifetime is based

on using the product in accordance with these

operating instructions. Once the designed lifetime

has been reached, safety-relevant products must be

replaced.

Designed lifetime (based on date of manufacture) in accordance with EN 230, EN 298 for FDU: 20 years. You can find further explanations in the applicable rules and regulations and on the afecor website (www.afecor.org).

This procedure applies to heating systems. For thermoprocessing equipment, observe local regulations.

13 SAFETY INSTRUCTIONS

Scope of application:
as set out in "Industrial thermoprocessing equipment – Part 2:

Safety requirements for combustion and fuel handling systems" (EN 746-2) when used with fuels and oxidants which emit UV radiation during oxidation.

Action:

Type 2 pursuant to EN 60730-1.

Behaviour under fault conditions:

Pursuant to Type 2.AD2.Y. During a fault, the FDU switches off and uses a trip-free mechanism which cannot be reclosed.

The flame failure detection time (FDRT) can be set using parameter A018 in BCSofT:
min. 0.7 s, max. 3,7 s.

Intermittent operation:

Possible pursuant to EN 298, Section 7.101.2.9. A flame simulation check must be conducted before starting the burner control unit.

Software class: corresponds to software class C which operates in a similar double-channel architecture with comparison.

Short-circuit fault exclusion:

No. Internal voltages are neither SELV nor PELV.

Interfaces

Type of wiring:

Attachment type X to EN 60730-1.

Connection terminals:

Supply voltage:

FDU..Q: 120 V AC, -15/+10%, 50/60 Hz, $\pm 5\%$,

FDU..W: 230 V AC, -15/+10%, 50/60 Hz, $\pm 5\%$,

between terminals L and N.

Ionization signal: 230 V AC between terminals ION (ionization output) and BM (burner ground). The voltage is provided by the FDU.

DC signal:

No flame: $< 2 \mu\text{A}$.

Active flame: 2 to 25 μA , depending on flame quality.

14 LOGISTICS

Transport

Protect the unit from external forces (blows, shocks, vibration).

Transport temperature: see page 9 (12 Technical data).

Transport is subject to the ambient conditions described.

Report any transport damage on the unit or packaging without delay.

Check that the delivery is complete.

Storage

Storage temperature: see page 9 (12 Technical data).

Storage is subject to the ambient conditions described.

Storage time: 6 months in the original packaging before using for the first time. If stored for longer than this, the overall service life will be reduced by the corresponding amount of extra storage time.

15 ACCESSORIES

Spare parts, see www.partdetective.de.

15.1 BCSoft4

The current software can be downloaded from our Internet site at www.docuthek.com. To do so, you need to register in the DOCUTHEK.

15.2 Opto-adapter PCO 200

Including BCSoft CD-ROM,
Order No.: 74960625.

15.3 Stickers for labelling

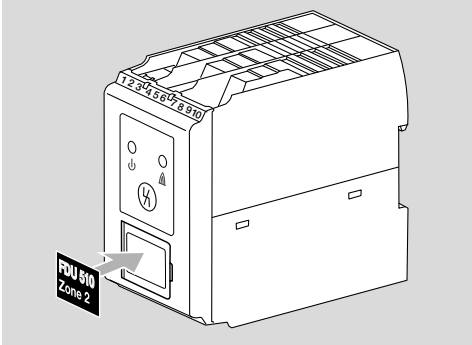

For printing with laser printers, plotters or engraving machines, 27 × 18 mm or 28 × 17.5 mm.
Colour: silver.

15.4 Connection plug set

For wiring the FDU 510, FDU 520.

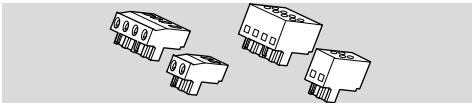

Connection plugs with screw terminals for FDU 510, FDU 520..K1

Order No.: 74924898.

Connection plugs with spring force terminals for FDU 510, FDU 520..K2

Order No.: 74924899.

16 CERTIFICATION

16.1 Certificate download

Certificates – see www.docuthek.com

16.2 Declaration of conformity



We, the manufacturer, hereby declare that the products FDU 510, FDU 520 comply with the requirements of the listed Directives and Standards.

Directives:

- 2014/35/EU – LVD
- 2014/30/EU – EMC
- 2011/65/EU – RoHS II
- 2015/863/EU – RoHS III

Standards:

- EN 298:2012
- EN 13611+A2:2011
- EN 60730-2-5:2020

Elster GmbH

16.3 SIL, PL



For systems up to SIL 3 pursuant to EN 61508.

Safety-specific characteristic values

Diagnostic coverage DC	94%
Type of subsystem	Type B to EN 61508-2
Mode of operation	High demand mode pursuant to EN 61508-4, continuous operation (to EN 298)
Mean probability of dangerous failure PFH _D	14.52 × 10 ⁻⁹ 1/h
Mean time to dangerous failure MTTF _d	1/PFH _D
Safe failure fraction SFF	95.53%

16.4 FM approved



Factory Mutual (FM) Research Class:

7610 “Combustion Safeguards and Flame Sensing Systems”.

Designed for applications pursuant to NFPA 86.

16.5 UL listed



For USA: Product Category MCCZ2, File No.

MP268,

for Canada: Product Category MCCZ8, File No.

MP268.

www.ul.com.

16.6 REACH Regulation

The device contains substances of very high concern which are listed in the Candidate List of the European REACH Regulation No. 1907/2006. See Reach list HTS at www.docuthek.com.

16.7 China RoHS

Directive on the restriction of the use of hazardous substances (RoHS) in China. Scan of the Disclosure Table China RoHS2, see certificates at www.docuthek.com.

17 DISPOSAL

Devices with electronic components:

WEEE Directive 2012/19/EU – Waste Electrical and Electronic Equipment Directive



At the end of the product life (number of operating cycles reached), dispose of the packaging and product in a corresponding recycling centre. Do not dispose of the unit with the usual domestic refuse. Do not burn the product.

On request, old units may be returned carriage paid to the manufacturer in accordance with the relevant waste legislation requirements.

FOR MORE INFORMATION

The Honeywell Thermal Solutions family of products includes Honeywell Combustion Safety, Eclipse, Exothermics, Hauck, Kromschöder and Maxon. To learn more about our products, visit ThermalSolutions.honeywell.com or contact your Honeywell Sales Engineer.

Elster GmbH
Strotheweg 1, D-49504 Lotte
T +49 541 1214-0
hts.lotte@honeywell.com
www.kromschroeder.com

Global centralized service deployment coordination:
T +49 541 1214-365 or -555
hts.service.germany@honeywell.com

Translation from the German
© 2024 Elster GmbH

Honeywell
kromschöder